



Dear customer,

Our DX line of coolers has become a default choice in high performance quiet cooling solutions for Intel Xeon CPUs and the latest i4 revision supports LGA2011 (both Square and Narrow ILM), LGA1356 and LGA1366 based Xeon platforms. Each Noctua product is double checked for flawless operation by our quality control team before it leaves the factory and I'm confident that you will be able to sense some of the research, attention and care we've put into making this product.

Enjoy your NH-U12DX i4!

Yours sincerely,

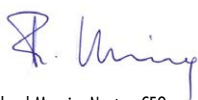

Roland Mossig, Noctua CEO

This manual will guide you through the installation process of the SecuFirm2™ mounting system step by step. Prior to installing the cooler, please verify that the cooler is fully compatible with your motherboard.

Should you encounter any difficulties, please check the FAQs on our website (www.noctua.at/faqs) and don't hesitate to contact our support team at support@noctua.at. Noctua cannot be held responsible for any damage or losses caused by compatibility issues.

Warranty, Support and FAQs

Even with high-grade products and strict quality control, the possibility of defects cannot be eliminated entirely. Therefore, we aim at providing the highest possible level of reliability and convenience by offering a warranty period of 6 years and direct, fast and straightforward RMA service.

Should you encounter any problems with your Noctua cooler, please don't hesitate to contact our support team (support@noctua.at).

LGA2011

There are two different types of ILM (Independent Loading Mechanism) for Intel's LGA2011 based Xeon CPUs: Square-ILM with 80x80mm hole spacing and Narrow-ILM with 56x94mm hole spacing.

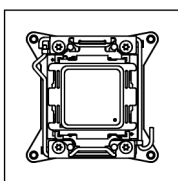

Square ILM

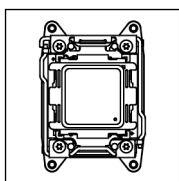

Narrow ILM

If your motherboard uses a Square-ILM, please continue as described below. If your motherboard uses a Narrow-ILM, please refer to section LGA2011 Narrow-ILM.

LGA 2011 Square-ILM

Applying thermal paste

If there are residual traces of thermal paste or thermal pads on your CPU, please clean them off first. Then press a small drop (4-5mm diameter) of NT-H1 onto the centre of the heatspreader.

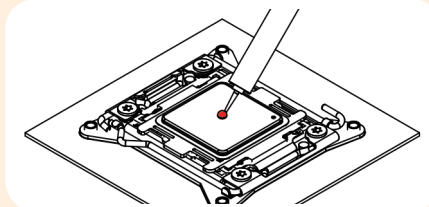

Caution: Applying too much thermal paste will lower heat conductivity and cooling performance!

Fastening the heatsink to the CPU

Caution: Please first take off the fan as well as the protection cover at the bottom side of the heatsink.

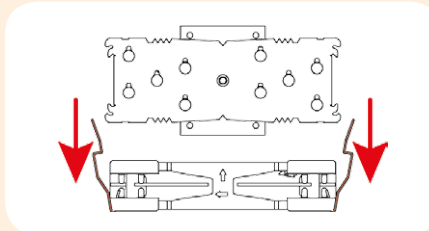

Then put the heatsink onto the CPU and tighten the four spring-loaded screws until they stop using the supplied screwdriver.

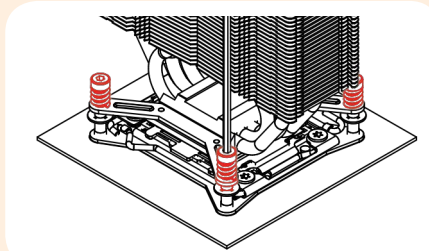

Caution: Tighten the screws until they stop.

Attaching the fans

Re-attach the fans to the heatsink using the steel clips:

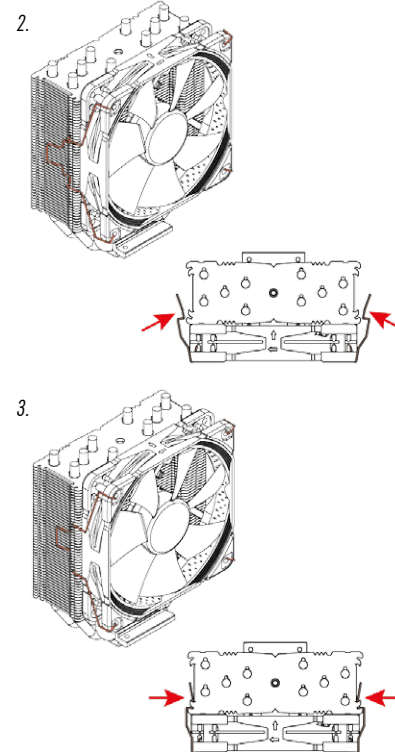
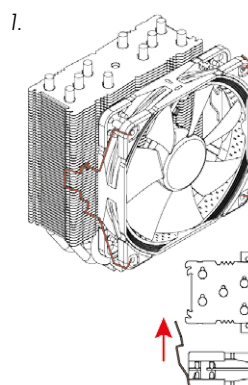

Connect the fan to the mainboard's CPU fan header.

Depending on your CPU and the temperature inside the case, you may interconnect the supplied NA-RC6 Low-Noise Adapter (L.N.A.) in order to further reduce the fan's operating noise.

Caution: When using the L.N.A., check the temperature of your CPU using appropriate software (e.g. the respective applications of your mainboard manufacturer), in order to evade automatic throttling of the CPU due to the increased temperature. If the cooling performance is insufficient, please increase case ventilation or remove the L.N.A.

Adding a second fan

The NH-U12DX i4 includes an extra set of fan clips and an extra set of thicker anti-vibration pads for installing a second NF-F12 fan in push/pull mode in order to further improve cooling performance.

Please use the thicker anti-vibration pads on the rear NF-F12 fan for improved acoustics if space allows. The y-cable supplied with the retail NF-F12 fan can be used to control the speed of both fans via the same mainboard fan header.

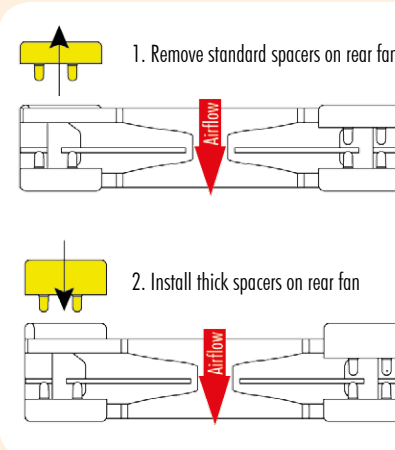



Scan this code to display multi-lingual manuals on your mobile phone.

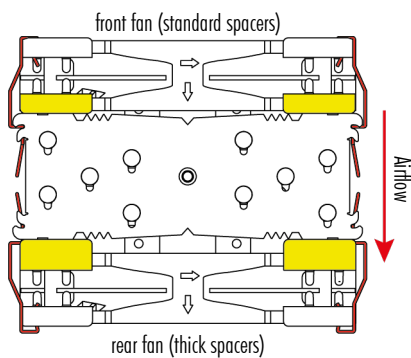

Clip position for thick spacers:

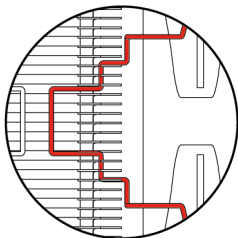

Clip position for standard spacers:

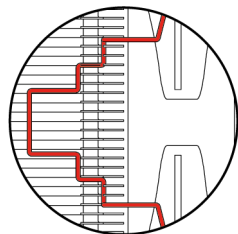

LGA2011 Narrow-ILM

Required mounting parts:

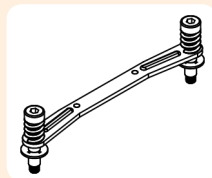

NM-XFB4 Standard Mounting Bar

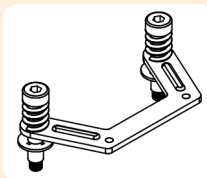

NM-XFB5 90° Mounting Bar

The LGA2011 Narrow-ILM uses a different hole spacing than Square-ILM, so please replace the pre-installed Square-ILM mounting brackets (NM-XFB3) with Narrow-ILM brackets (NM-XFB4 or NM-XFB5) as described below.

This manual will guide you through the installation process step by step using the NM-XFB5 bracket as an example. Please note that the installation procedure is identical for NM-XFB5 and NM-XFB4.

First choose the appropriate set of Narrow-ILM mounting brackets according to the desired orientation of the cooler:

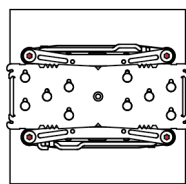

NM-XF4

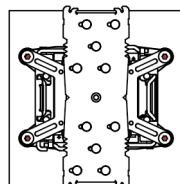

NM-XFB5

Unscrew the preinstalled LGA2011 Square-ILM mounting brackets (NM-XFB3) and take them off the heatsink.

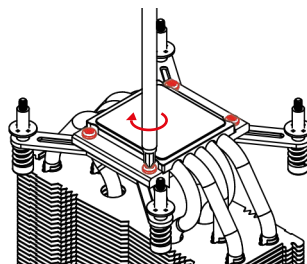

Then remove the plastic lock-rings, springs and screws from the Square-ILM mounting brackets and put them into the Narrow-ILM mounting brackets.

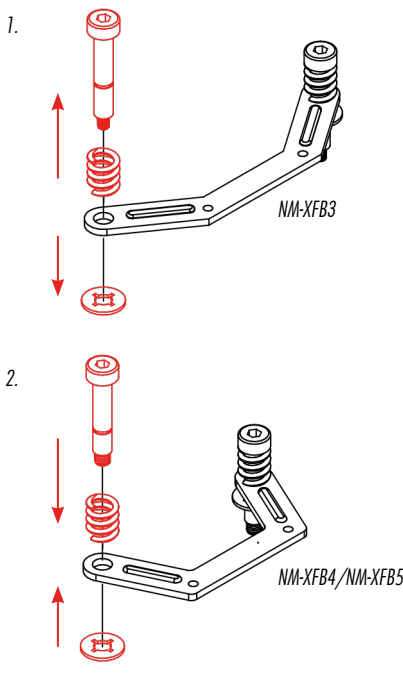

After you've fixed the springs and screws to the appropriate Narrow-ILM fastening brackets, please screw the brackets to the heatsink.

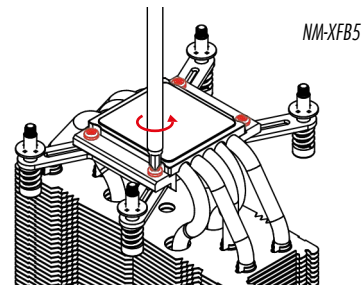
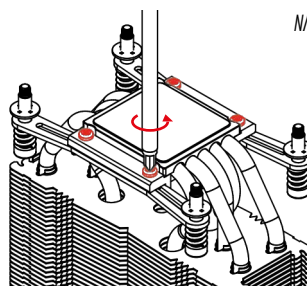

Then proceed with the steps described in section LGA2011 Square-ILM.

LGA1356/1366

Required mounting parts:



NM-XBT2 Screws (black)

LGA1356/1366 uses a different thread than the pre-installed screws for LGA2011 (NM-XBT1), so please change the screws as described below.

Remove the plastic lock-rings, springs and screws (NM-XBT1) from the mounting brackets.

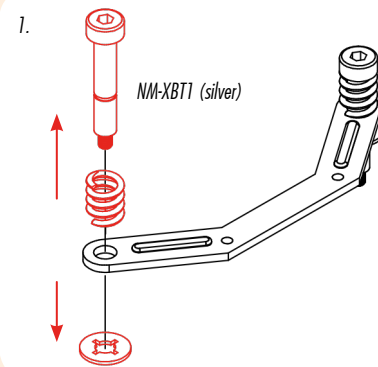

Then use the springs and the lock-rings to fix the black LGA1356/1366 screws (NM-XBT2) to the mounting brackets.

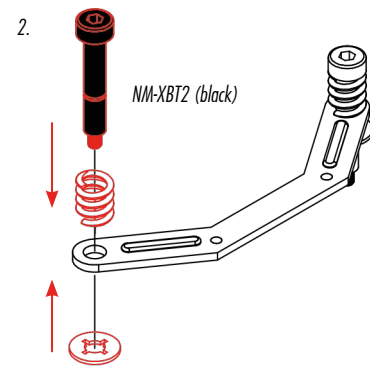

After you've fixed the springs and screws to the mounting brackets, please proceed with the steps described in section LGA2011 Square-ILM.