

NA-SAVG1

Noctua NA-SAVG1 3x Anti-Vibration Gaskets

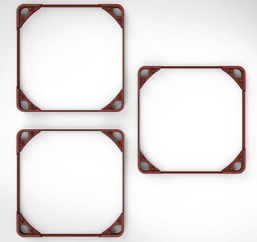

The NA-SAVG1 is a set of three NA-AVG1 anti-vibration gaskets for using compatible Noctua 120x25mm fans on water cooling radiators or other applications that benefit from a tighter seal with the fan. Made from extra soft yet highly tear-proof silicone rubber, the NA-AVG1 help to damp minute vibrations and to reduce air loss between the fan and the radiator. As such, they are an ideal accessory for performance enthusiasts who want to squeeze out those extra few percent of cooling efficiency.

Fine-tuning airflow efficiency

Why get the best fans for your water cooler and then let air escape between the fan and the radiator? Yielding a few tenths of a degree in CPU temperatures may not seem relevant to many, but for performance enthusiasts who relentlessly pursue perfection in optimising their systems, the NA-AVG1 can be the finishing touch in achieving ultimate efficiency.

Compatible with most Noctua 120x25mm fans

The NA-AVG1 gaskets are compatible with all current Noctua 120x25mm fans, including the award-winning NF-A12x25, NF-F12, NF-S12A and NF-P12 redux series. The 120x15mm NF-A12x15 series fans are not supported.

Set of 3, ideal for 360mm radiators

Containing 3 NA-AVG1 gaskets, the NA-SAVG1 set enables customers to equip up to three compatible 120x25mm fans. Perfect for getting the most out of water cooling setups with 240 or 360mm radiators.

Easy installation, compatible with screws or anti-vibration mounts

Attaching through the same holes as Noctua's standard NA-AVP1 anti-vibration pads, installation of the NA-AVG1 is a breeze. Leaving the fan's screw holes uncovered, the gaskets are fully compatible with standard fan mounting screws, radiator screws or anti-vibration mounts such as Noctua's NA-AV1, NA-AV2, NA-AV3 or NA-AV4.

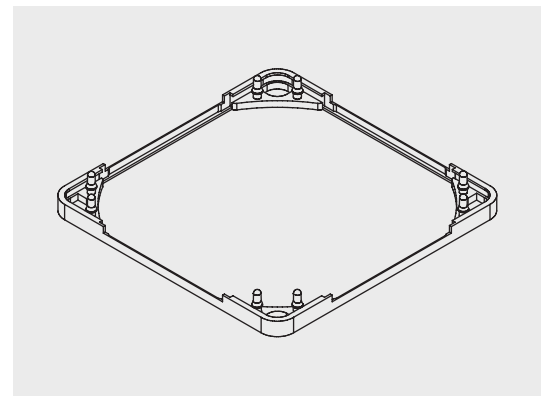

LOGISTIC DATA

Product name

Noctua NA-SAVG1

EAN

9010018201147

UPC

841501121142

Packaging dimensions (HxWxD)

150x110x30 mm

Weight incl. packaging

70 g

Warranty

6 years

Packaging unit

40 pcs

Packaging dimensions / unit (HxWxD)

320x320x240 mm

Weight incl. packaging / unit

3.28 kg

SCOPE OF DELIVERY

3x NA-AVG1 anti-vibration gasket
for water cooling radiators