

NA-SYC1

Noctua NA-SYC1 2x 4-Pin Y-Cables



The NA-SYC1 is a fan accessory set consisting of two fully sleeved NA-YC1 Y-Cables for 4-pin PWM fans. The NA-YC1 Y-Cables make it possible to run two 4-pin PWM fans on a single fan header and to let the mainboard control the speed of both fans simultaneously. Multiple NA-YC1 can be daisy-chained to control more than two PWM fans via one header.

LOGISTICAL DATAS

Product Labeling

Noctua NA-SYC1

EAN-No.

4716123315193

UPC-No.

842431013309

Dimensions (HxWxD)

150 x 111 x 29 mm

Weight

60 gr

Warranty

6 Years

MSPR

5.90 EUR

Packaging Unit

40 Pcs.

Dimensions / Unit (HxWxD)

320 x 320 x 240 mm

Weight / Unit

3.04 kg

SCOPE OF DELIVERY

2x NA-SYC1

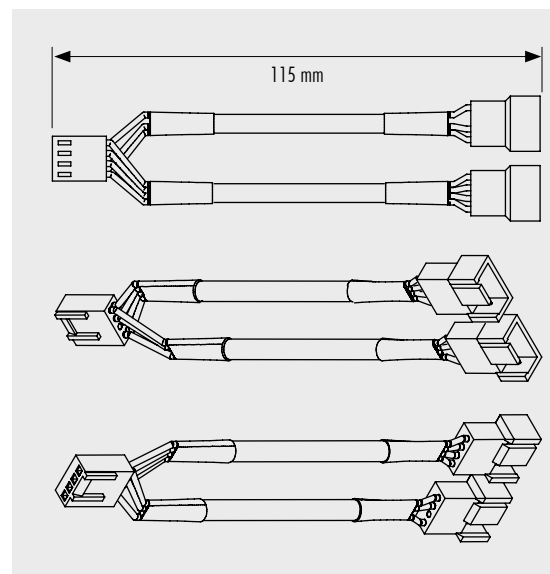

Caution: Common mainboard fan headers support up to 9.6 or 12W (check your mainboard manual for detailed information). Therefore please make sure that the combined power draw of the fans connected to one fan header using NA-YC1 adaptors does not exceed this value!