

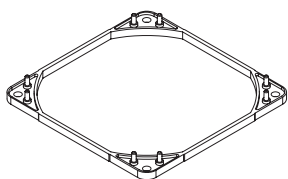

Designed to replace the fan's stock NA-AVP1 anti-vibration pads, the NA-IS1-12 are compatible with all current square-frame Noctua 120x25mm fans and extremely straightforward to install:

For case fan applications, either the supplied self-tapping screws or the included NA-AV3 anti-vibration mounts can be used to sandwich the spacer between the fan and the case panel. For radiator mounting, both M3 and UNC 6-32 screws are supplied.

Included mounting parts:



2x NA-IS1-12 inlet spacers

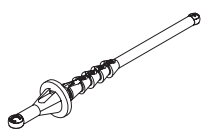

8x NA-AV3
anti-vibrations mounts



8x NM-SFS4-BK
long fan screws



8x NM-SFS5-BK
radiator screws (M3)



8x NM-SFS6-BK
radiator screws (UNC)

1 Case fan installation with NA-AV3

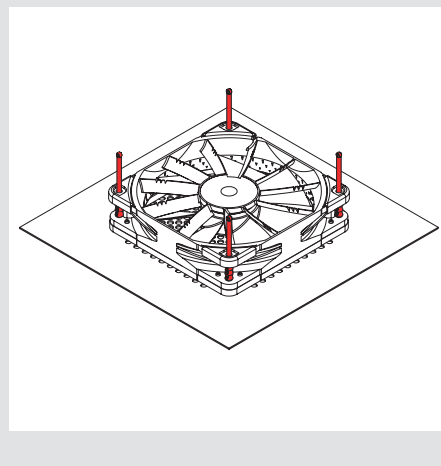
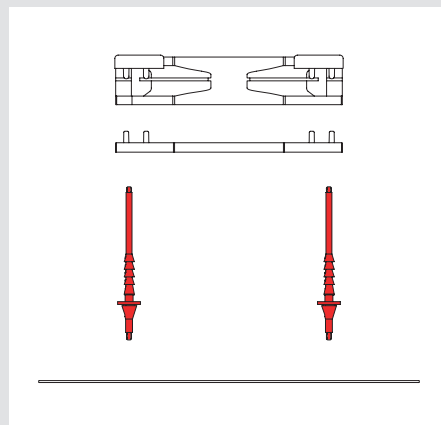
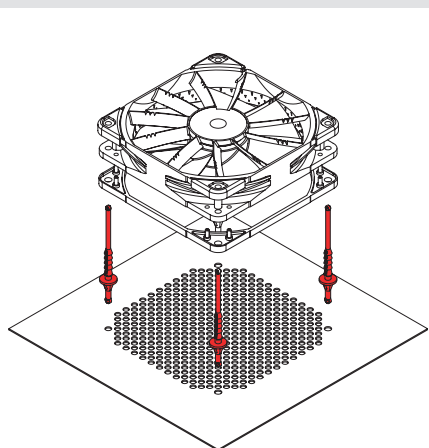

2 Case fan installation with screws

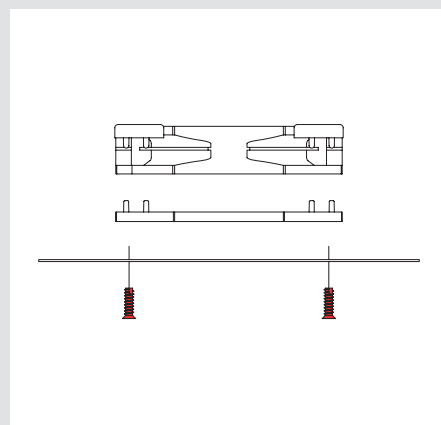
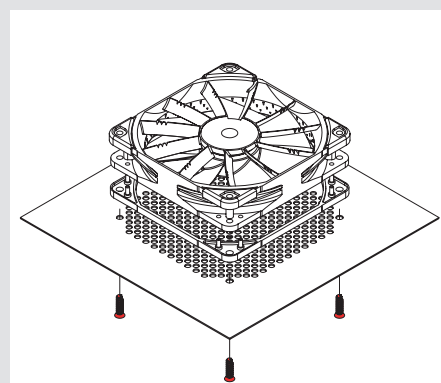

3 Radiator installation

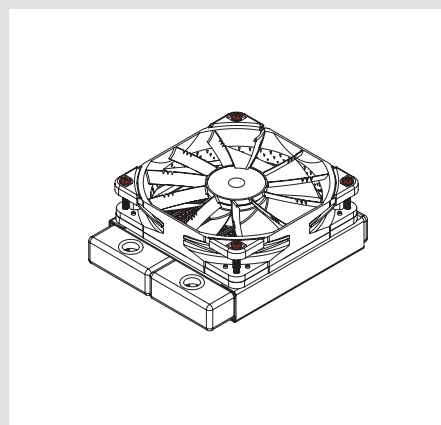
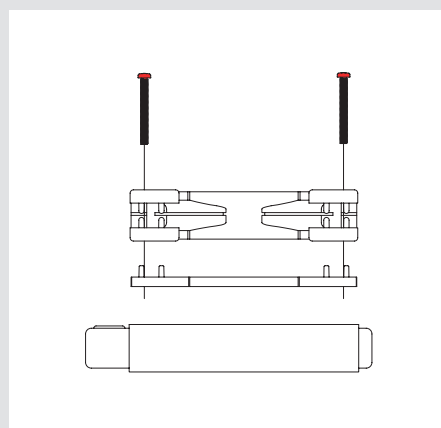
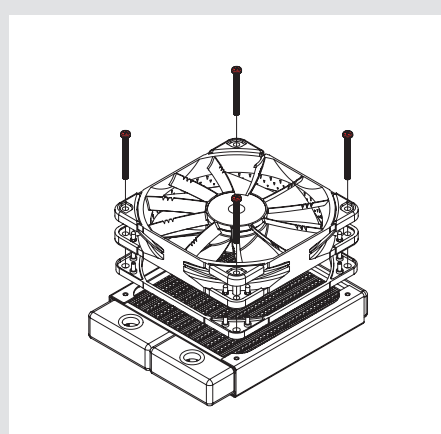



! Caution

We supply both M3 thread (small head) and UNC 6-32 thread (bigger head) screws. Please make sure to select the correct screw type for your radiator (refer to manufacturer specifications or contact manufacturer)!

M3

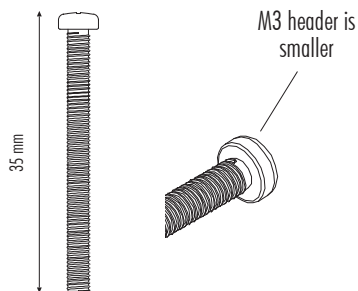

UNC

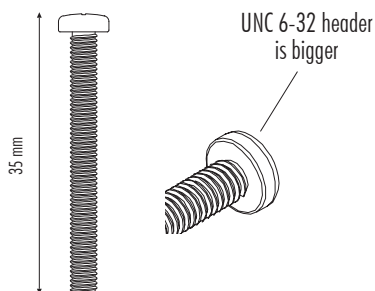

! Warranty, support and FAQs

Even with high-grade products and strict quality control, the possibility of defects cannot be eliminated entirely. Therefore, we aim at providing the highest possible level of reliability and convenience by offering a warranty period of 6 years and direct, fast and straightforward RMA service.

Should you encounter any problems with your NA-IS1-12 Sx2, please don't hesitate to contact our support team at support@noctua.at.

Please also consult the FAQ section on our website: www.noctua.at/faqs