

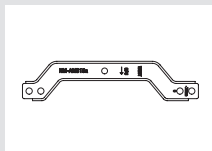

Required mounting parts:

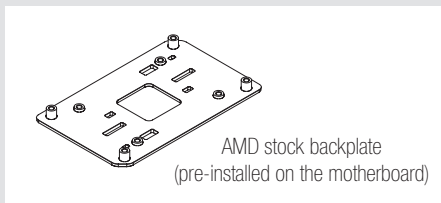

NM-AMB15a
mounting bar

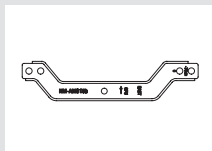

NM-AMB15b
mounting bar

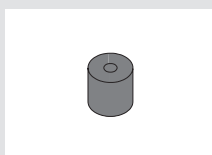

4x NM-APS4
grey plastic spacers
(not included)

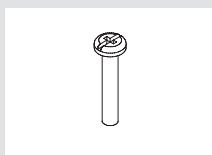

4x NM-ALS1
long screws
(not included)

! Caution

If your CPU cooler is already installed, please first unscrew it from the original mounting bars. Then, unscrew the original mounting bars from the backplate and remove them.

If your CPU cooler is not yet installed, please first remove the motherboard's heatsink retention module and put the plastic spacers over the threads of the motherboard's backplate, as described in the manual that came with the cooler.

1 Installing the mounting bars

Install the offset mounting bars as shown below:

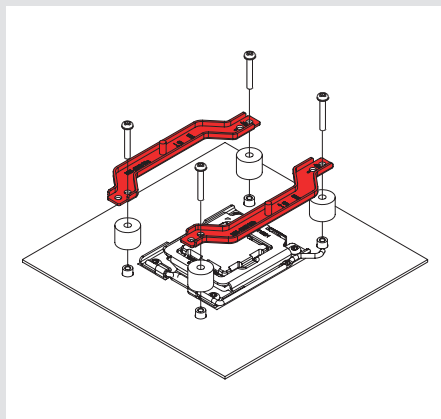

On AM5 and Ryzen 5000/3000 series AM4 CPUs, choose the -7mm offset hole position to ensure optimal contact quality and performance.

On other AM4 CPUs, or if there are any compatibility issues in the offset position (e.g. clearance with motherboard heatsinks), please choose the standard position (0).

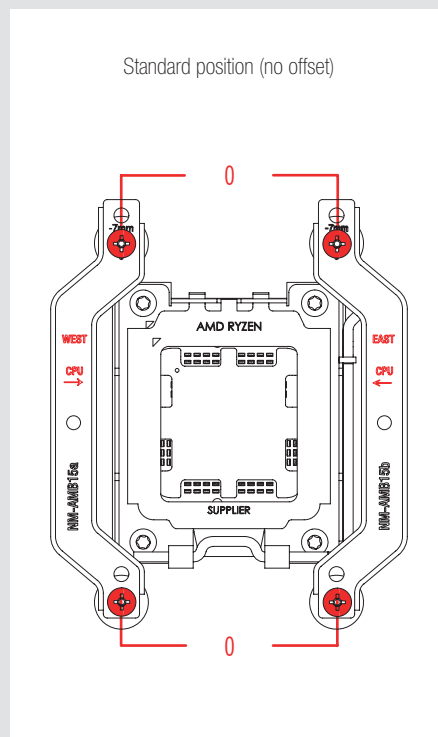
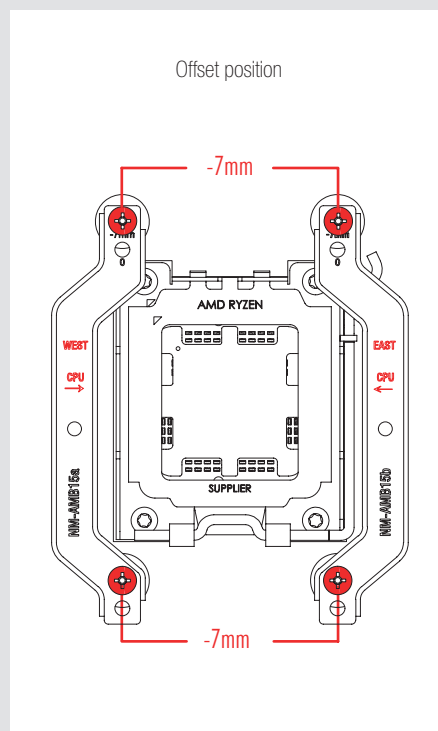
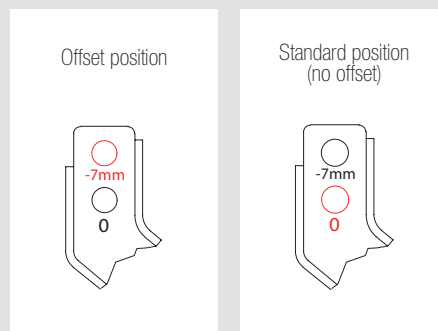

Caution: Make sure that the "CPU →" markings point towards the CPU and that the NM-AMB15a bar with the "WEST" marking is installed on the west (left) side of the socket and the NM-AMB15b bar with the "EAST" marking is installed on the east (right) side of the socket.

Fix the offset bars using the screws that came with the cooler.

Caution: Gently tighten the screws until they stop, but do not use excessive force (max. torque 0.6 Nm).

Once you have screwed the offset mounting bars to the backplate, proceed by applying thermal paste and installing the cooler to the mounting bars, as described in the manual that came with the cooler.